

iD TILT HIT

LUXURY VINYL TILES

High performance interlocking tiles for heavy traffic settings





iD TILT HIT

The iD Tilt HIT range is Tarkett's **most robust flooring** collection, designed for very heavy and high traffic areas in commercial and industrial settings.

The perfect blend of design and performance, it is available in 3 multi pattern industrial grey shades and features a 2.7mm thick homogeneous wear layer for **superior durability and dimensional stability**.

Ideal for use in stores and shops, industrial warehouses and industry, the iD Tilt HIT emits **less noise** than ceramic alternatives and provides a more comfortable surface underfoot for the user.

The modular interlocking tiles can **quickly and easily be installed on top of a variety of existing surfaces**, reducing business downtime and associated costs. Offering both a hard wearing and sustainable solution, the iD Tilt HIT range is recyclable, phthalate-free, with ultra-low VOC.

Finished with the **TopClean XP® PU coating for easy maintenance**, it boasts best-in-class resistance to scuffs, scratches and stains, keeping the floor looking and performing at its best for the lifetime of the product.

Stores & Shops

The iD Tilt HIT is perfect for small and medium sized supermarkets with high footfall and low downtime. The thick wear layer is **hard wearing and resistant** to regular use from loaded pallet jacks and shelves full of liquid bottles.

Suitable **for new or renovation projects**, the loose-lay, interlocking tiles are four times quicker to install than ceramics and ready for immediate use. No adhesive means no drying time or mess, so there is no need to close the retail outlet and lose turnover.

CUSTOMER COMFORT AND SATISFACTION

Ideal for customer facing areas, there's no compromising on aesthetics. The iD Tilt HIT range provides a continuous floor with no grout lines, making it easier to keep clean and looking its best. The floor's noise reducing properties combat the sound emission of shopping carts and walking, **maximising customer comfort and satisfaction**.



KEY BENEFITS

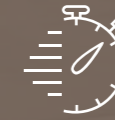

Faster and simpler to install than ceramics



Cost effective – reduced labour and downtime



High resistance to heavy loads



Improved acoustics for a better user environment

Warehouse

KEY BENEFITS



Faster and simpler to install than resin



Cost effective – reduced labour and downtime



High resistance to heavy loads



Improved acoustics for a better user environment

Reduce downtime and maintenance with the iD Tilt HIT flooring system. Ideally suited to small and medium sized warehouses with heavy footfall and inventory, the modular LVT tiles are quicker and easier to install than resin alternatives. Suitable **to apply over existing floors**, the interlocking tiles require no adhesive, enabling the warehouse to be **back in operation immediately** after installation.

LOW MAINTENANCE AND HIGHLY RESISTANT

With a TopClean XP® PU surface treatment, the iD Tilt HIT requires minimal maintenance and is highly resistant to heavy loads and wear from high footfall. For **user comfort and safety**, the thick wear layer provides a soft surface finish that reduces the impact on users' joints.

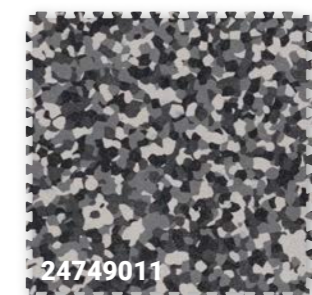

Industry

For industrial applications such as laboratories and light machinery plants, iD Tilt HIT provides the perfect combination of easy maintenance and heavy traffic resistance.

The thick wear layer and interlocking tiles are designed to **withstand heavy loads such as CNC machines and materials that require moving**. With no grout lines, the tiles create a continuous floor with a smooth surface finish which is quick and easy to install and maintain.

DESIGNED TO REDUCE JOINT STRESS

Prioritising the comfort of employees working in the light industrial sector, the **soft surface** finish is designed **to reduce the stress put on joints** during continuous use. And for a better working environment, the floors' acoustic properties minimise the noise produced from machinery movement and walking.



KEY BENEFITS



Faster and simpler to install than resin



Cost effective – reduced labour and downtime



High resistance to heavy loads



Improved acoustics for a better user environment

iD TILT HIT



PREMIUM DURABILITY & PERFORMANCE

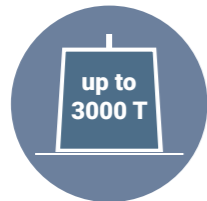

Robust flooring collection designed for very **heavy loads** and **high traffic areas**



Best-in-class **dimensional stability**



PATENT PENDING

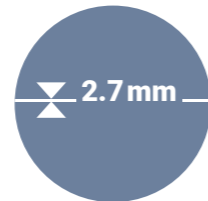

2.7mm thick wear layer, for **increased durability**

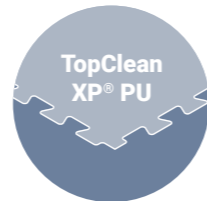

Excellent TopClean XP® PU surface treatment – **Easy to clean and maintain**



QUICK & EASY INSTALLATION



Easy to install, highly resistant interlocking tiles for **rapid lay and replace**

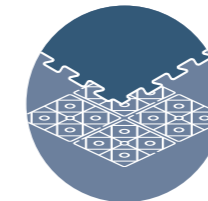

Suitable for **installation over a variety of existing surfaces** e.g. ceramics, resin, humid subfloor

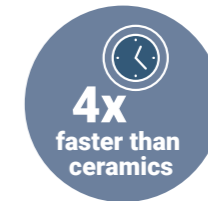

Minimising downtime in commercial & industrial areas



DESIGNED FOR COMFORT & SAFETY



Best-in-class reduced noise from rolling and walking (21dB noise reduction vs ceramics)



Homogeneous wear layer softens contact with the floor, **preventing joint issues**



More **slip resistant** than other types of flooring



GOOD FOR PEOPLE & PLANET



Phthalate free



Platinum level with $\leq 10 \mu\text{g}/\text{m}^3$, this is **100 times lower** than industry standards*

* after 28 days



A glue-free solution that can be easily disassembled and **recycled post-use**



Made in Europe



Product construction

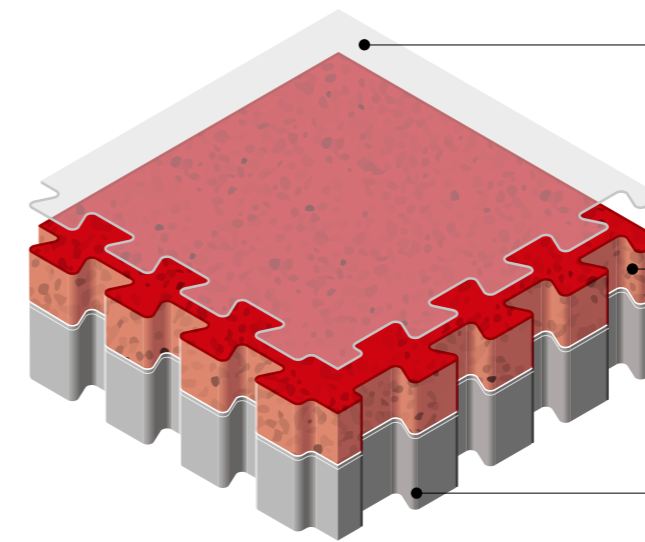

1 TOPCLEAN XP® PU COATING

Easy to clean and maintain – with best in class resistance to scuffs, scratches and stains

2 HOMOGENEOUS WEAR LAYER

Robust 2.7mm thick wear layer, for increased durability, available in 3 designs

3 CORE LAYER WITH GLASS FIBER REINFORCEMENT

Best-in-class dimensional stability and resistance to tear and indentation

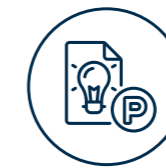

PATENTS PENDING

- Unique combination of formulation & double glass veil reinforcement for improved dimensional stability
- Unique design of the locking system improving resistance to thermal dilatation

Good for People & Planet

The pursuit of 'always more' is pushing our limits and threatening our planet. The game must change. We need to find a way to deliver more with less. For us, this means less waste, lower emissions, greater well-being and more proof.

The way to better floors.

MORE PROOF.

To achieve the highest health and sustainability standards, **iD Tilt HIT is eco-designed** according to the Cradle to Cradle® principles, a methodology that guides us in our good materials choices. We use phthalate-free plasticisers – including recycled content – that are approved for use in young children's toys and food packaging. iD Tilt HIT is made in Europe.



LESS WASTE, LOWER EMISSIONS.

Tackling climate change and resource scarcity is an imperative that demands a total commitment to a circular economy. **Recycling flooring** not only conserves the world's natural resources, but helps to tackle climate change by cutting out the energy and water needed to extract and process virgin materials and the GHG emissions from incineration.

iD Tilt HIT is a glue-free solution that can be easily disassembled and recycled post-use. Join our **ReStart® programme** and make sure your installation waste and your old floors are collected and recycled into new Tarkett flooring.



GREATER WELLBEING.

By driving down VOC emissions, our products exceed the strictest industry standards for air quality by so much, we've had to set our own standards. Standards that we can prove with science, not just words. It means you can breathe easy, knowing you made a good choice for your flooring.

iD Tilt HIT reaches Platinum level with $\leq 10 \mu\text{g}/\text{m}^3$, this is 100 times lower than industry standards.



Accessories

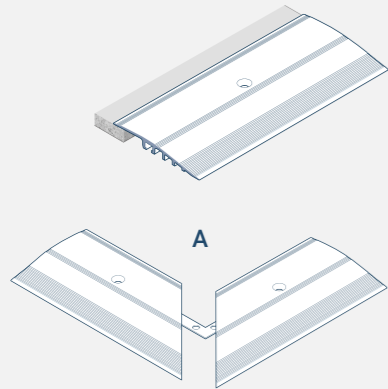

RAMP PROFILE ALUMINIUM

Designed to support heavy rolling loads to access the heavy duty interlocking iD Tilt HIT flooring. Designed for 6 mm thickness floor covering. To be screwed.

Size: 300cm length x 7.6cm width x 0.6cm height
1 box = 5 pieces (15 lm)

263999 001

A CORNER RAMP PROFILE ALUMINIUM

1 box = 1 piece

263998 001

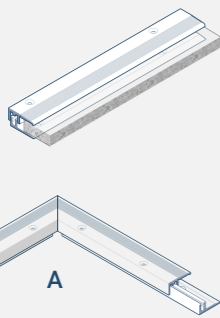

FRAME - ENTRANCE CARPET

Designed to set an entrance mat area within an LVT flooring. Can be used with 5 to 11.5 mm thickness flooring product.

Included:

- A base with drilled hole to be screwed on the floor
- A capping bar to be screwed on top of the base
- Screw and Plugs

Size: 270cm length x 2.2cm width x 1.15cm height
1 box = 10 pieces (27 lm)

263991 001

A FRAME ANGLE - ENTRANCE CARPET

1 box = 1 unit

263990 001



WARNING TAPE BLACK-YELLOW

Warning tape with very high adhesive power. Enhanced surface resistance provided by aluminium oxide. Can be used indoor or outdoor. Installed on a floor temperature $\geq 10^{\circ}\text{C}$.

Size: 1800cm length x 5cm width
1 roll

210999 001

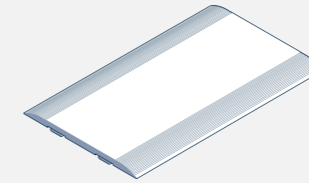

TRANSITION PROFILE ALUMINIUM

Designed to support heavy rolling loads which facilitate the access between two heavy duty interlocking iD Tilt HIT flooring areas. To be screwed.

Size: 300cm length x 10cm width x 0.5cm height
1 box = 5 pieces

263997 001

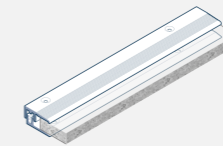

STOP PROFILE ALUMINIUM

Adjustable stop profile up to 11.5 mm thickness for high traffic areas. To be screwed.

Size: 270cm length x 2.2cm width x 1.15cm height
1 box = 10 pieces

263991 001

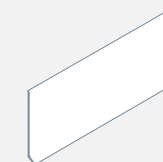

SKIRTINGS ALUMINIUM

To provide strong base wall protection and an elegant finish. Installation of the skirtings to be done with corners, connectors and ending parts.

Size: 270cm length x 1cm width x 8cm height
1 box = 10 pieces (27 lm)

263994 001

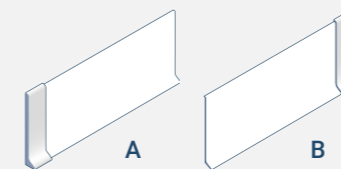

A LEFT END CAP

1 box = 1 piece

263992 001

B RIGHT END CAP

1 box = 1 piece

263992 002

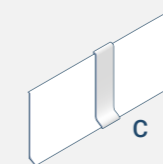

C CONNECTOR

1 box = 1 piece

263992 003

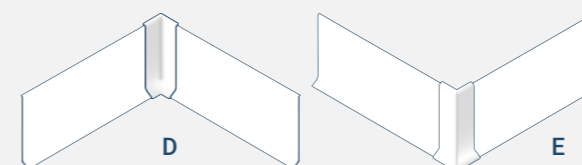

D INNER CORNER

1 box = 1 piece

263993 001

E OUTER CORNER

1 box = 1 piece

263993 002

Colours

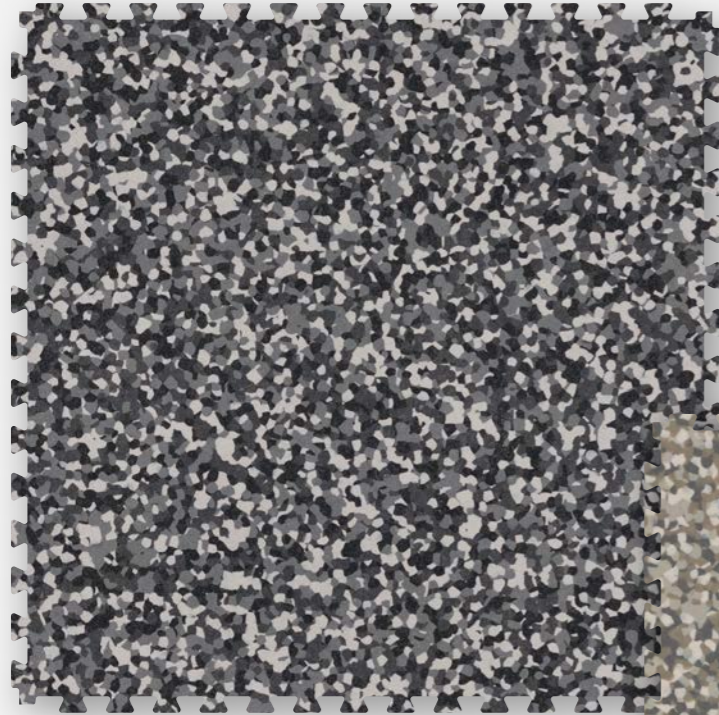

MULTI BLACK MIX / 24749011
LRV 15% / NCS S 6502-B



MULTI WARM GREY MIX / 24749013
LRV 29% / NCS S 4502-Y



MULTI COOL GREY MIX / 24749012
LRV 29% / NCS S 4502-B



iD TILT HIT

TECHNICAL DATA	STANDARD	iD TILT HIT
CLASSIFICATION		
Product type	EN ISO 10582	Heterogeneous poly (vinyl chloride) floor coverings
Classification	EN ISO 10874	Commercial: 34 Very heavy / Industrial: 43 Heavy
Wear layer binder content	EN ISO 10582	Type I
TECHNICAL CHARACTERISTICS		
Total thickness	EN ISO 24346	6.0 mm
Wear layer thickness	EN ISO 24340	2.7 mm
Total weight	EN ISO 23997	10000 g/m ²
Surface treatment		Yes - TopClean XP®
Bevelled edges		No
Installation method		Interlocking
Form of delivery	EN ISO 24342	64.5 x 64.5 cm
	Tiles (box)	4 tiles=1.59 m ² /box - 48 boxes/pallet
PERFORMANCES FOR CE MARKING		
Declaration of Performance	EN 14041	0197-0015-DoP-2021-10
TECHNICAL PERFORMANCES		
Dimensional stability	EN ISO 23999	≤ 0.15% (Average measure value ≤ 0.10%)
Curl resultant to heat	EN ISO 23999	≤ 111 mm
Reaction to fire	EN ISO 13501-1	B _{f1} -s1
Residual indentation	EN ISO 24343-1	≤ 0.10 mm
Furniture leg effect	EN ISO 16581	No damage
Castor chair effect	EN ISO 4918	No damage
Impact sound reduction - ΔLw	EN ISO 717-2	6 dB
Reduction of in-room impact noise	NF S31-074	Class C (≤ 85 dB)
Colour fastness to light	EN ISO 105-B02	≥ 6
Chemical resistance	EN ISO 26987	Not affected
Slip resistance	DIN 51130	R10
Slip resistance	EN 13893	Class DS (μ ≥ 0,30)
Peeling Resistance	EN ISO 24345	≥ 100N/50mm
Underfloor heating		Suitable (maximum 27°C)
SUSTAINABILITY PERFORMANCES		
Recyclability through ReStart®		Recyclable
Total VOC emissions	EN 16516 Gold	≤ 10 μg/m ³ (after 28 days)
Phthalate - free		Yes
COLOURS		
Colours		3

The above information is subject to modification for the benefit of further improvement (15/12/2022). According to the European Regulation N°305/2011 for CE Marking, the Declarations of Performance are available on our website <https://www.tarkett.com>. Tarkett's instructions regarding installation, cleaning and maintenance should be observed. Please contact Tarkett at the address shown for the instructions.



Tarkett Human-Conscious Design®

Tarkett Human-Conscious Design® is our pledge to stand with present and future generations. To create flooring and sports surfaces that are good for people and for the planet. And to do it every day.

We deliver on this through the synergy of three commitments:

- 1 Deep human understanding
- 2 Conscious choices. For people and planet
- 3 With you. Every step of the way

The designs and photos used in this brochure are for illustration purposes only. They are not contractual images and do not stand for product or installation recommendation.

© Tarkett, December 2022

Front image: 24749011

professionals.tarkett.com





■ **WESTERN EUROPE:** Austria: Tarkett Holding GmbH, Niederlassung Wien – Tel. +43 1 47 88 062 ■ Belgium: Tarkett Belux Sprl – Tel. +32 52 26 24 11
■ Denmark: Tarkett A/S – Tel. +45 43 90 60 11 ■ Finland: Tarkett Oy – Tel. +358 9 4257 9000 ■ France: Tarkett SAS – Tel. +33 1 41 20 42 49 ■ Germany: Tarkett Holding GmbH – Tel. +49 621 68172 300 ■ Greece: Tarkett Monoprosopi Ltd – Tel. +30 210 6745 340 ■ Italy: Tarkett S.p.A. – Tel. +39 0744 7551 ■ Luxembourg: Tarkett GDL SA – Tel. +352 949 211 8804 ■ Netherlands: Tarkett BV – Tel. +31 416 685 491 ■ Norway: Tarkett AS – Tel. +47 32 20 92 00 ■ Portugal: Tarkett SA – Tel. +351 21 427 64 20 ■ Spain: Tarkett Floors S.L. – Tel. +34 91 358 00 35 ■ Sweden: Tarkett Sverige AB – Tel. +46 771 25 19 00 ■ Switzerland: Tarkett Holding GmbH – Tel. +41 043 233 79 24 ■ Turkey: Tarkett Aspen – Tel. +90 212 213 65 80 ■ United Kingdom: Tarkett Ltd – Tel. +44 (0) 1622 854 040 ■ **EASTERN EUROPE:** Baltic Countries: Tarkett Baltics: Tel. +370 37 262 220 ■ Czech Republic: Tarkett org. slozka – Tel. +420 271 001 600 ■ Hungary: Tarkett Polska SP Z.O.O. magyarorsz gi fi ktelepe – Tel. +36 1 437 8150 ■ Poland: Tarkett Polska Sp. z o. o. – Tel. +48 22 16 09 231 ■ Russian Federation: ZAO Tarkett RUS – Tel. +7 495 775 3737 ■ Slovakia: Tarkett Polska, organizačn zlozka – Tel. +421 2 48291 317 ■ South East Europe: Tarkett SEE – Tel. +381 21 7557 649 (44) 569 12 21 ■ Ukraine: Tarkett UA – Tel. +38 (0) 44 35 45 621 ■ **ASIA AND OCEANIA:** Australia: Tarkett Australia Pty Ltd – Tel. +61 2 88 53 12 00 ■ China: Tarkett Floor Covering (Shanghai) Co. Ltd. – Tel. +86 (21) 60 95 68 38 ext 841 ■ North East Asia: Tarkett Hong Kong Limited – Tel. +852 2511 8716 ■ India: Tarkett Flooring India Pvt. Ltd. – Bangalore - Tel. +91 80 4130 3793 – New Delhi - Tel. +91 11 4352 4073 – Mumbai - Tel. +91 22 2648 8750 ■ South East Asia: Tarkett Flooring Singapore Pte. Ltd. – Tel. +65 6346 1585 ■ **AFRICA:** Tarkett International: Tel. +33 1 41 20 41 01 ■ **MIDDLE EAST:** Tarkett Middle East: Tel. +961 1 51 3363/4 ■ Israel: Tarkett International: Tel. +33 1 41 20 41 01 ■ **NORTH AMERICA:** USA: Tarkett Inc. – Tel. +1 713 869 5811 / Johnsonite – Tel. +1 440 543 8916 ■ Canada: Tarkett Inc. – Tel. +1 450 293 173 ■ **LATIN AMERICA:** Brazil: Tarkett – Tel. 55 12 3954 7108 ■ Argentina - Chile - Uruguay: Tarkett Latam Mercosur – Tel. +54 11 47 08 07 72 / +54 9 11 44 46 88 82 ■ Bolivia - Colombia - Ecuador - Panama - Paraguay - Peru - Trinidad and Tobago - Venezuela: Tarkett – Tel. +55 11 9 8410 9310 / +55 11 95494 0069 ■ Mexico /Central America: Tarkett Latam Mexico – Tel. +55 11 98410 9310

professionals.tarkett.com

